

CHRIS MONTAGUE

A great deal more than
just a carburetter company

AIR FILTERS AIR TRUMPETS ALTERNATORS BATTERIES BATTERY
MASTER SWITCHES BODY STYLING BONNET HOOKS BONNET PINS
BRAKE PARTS CAMSHAFTS CARBURETTERS DYNAMOS ELECTRONIC
IGNITION FANS FIRE EXTINGUISHERS FUEL PUMPS HARNESSSES
INSTRUMENTS LAMP BARS LAMP BRACKETS LAMPS LOCKWIRE
MANIFOLDS MANUAL CHOKE CONVERSIONS OIL OIL COOLERS RACE
NUMBERS RACE TAPE REGULATORS ROAMERS SHOCK ABSORBERS
SPARK PLUGS STARTER MOTORS STEERING WHEELS THROTTLE LINK-
AGES TOOLS TURBOCHARGERS TYRE GAUGES WHEELS WIRE TWISTING
PLIERS AIR FILTERS AIR TRUMPETS ALTERNATORS BATTERIES BATTERY
MASTER SWITCHES BODY STYLING BONNET HOOKS BONNET PINS
BRAKE PARTS CAMSHAFTS CARBURETTERS DYNAMOS ELECTRONIC
IGNITION FANS FIRE EXTINGUISHERS FUEL PUMPS HARNESSSES
INSTRUMENTS LAMP BARS LAMP BRACKETS LAMPS LOCKWIRE
MANIFOLDS MANUAL CHOKE CONVERSIONS OIL OIL COOLERS RACE
NUMBERS RACE TAPE REGULATORS ROAMERS SHOCK ABSORBERS

**CHRIS
MONTAGUE**
CARBURETTER CO.

*Suppliers
to the Garage
and Retail
Trade.*

DISTRIBUTORS OF SPECIALISED MOTOR COMPONENTS & ACCESSORIES
380-382 Finchley Road, London NW2 2HP. Telephone: 01-794 7766/7
Telex: 295441 Fax: 01-209 1231

Try us first when you're looking for quality spares & accessories.

ENGINE

CARBURETTERS

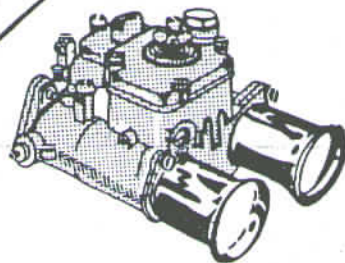

Weber The carburettor on which Chris Montague Carburettor Company built its name. We claim to hold the widest spread of stock of Weber carburettors and spares in the UK which includes standard replacement units together with all the renowned Weber performance conversions. Special competition carburettors and conversions too!

Please note that, as well as conversions, we keep comprehensive stocks of original equipment Weber carburettors.

Dellorto Full range of carburettor units and spares.

Pierburg Carburettors and spares for vehicles fitted with these as original equipment, i.e. certain models of Audi, BMW, Ford, Mercedes, Opel, Peugeot & Volkswagen.

Zenith Replacement units and spares stocked for U.K. and French cars.

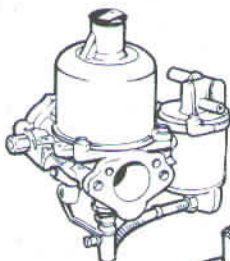

S. U. Replacement units plus extensive stock of needles, jets & other spares.

Solex Replacement units and spares for U.K., French, Italian & German cars.

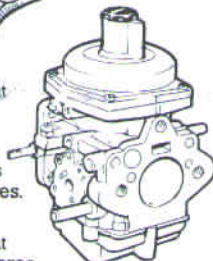

Carburettor Conversions

1) For the majority of vehicles, where the original carburettor has proved troublesome, or is expensive to replace with a new unit of the same make, we can offer a proven conversion using an alternative make of carburettor.

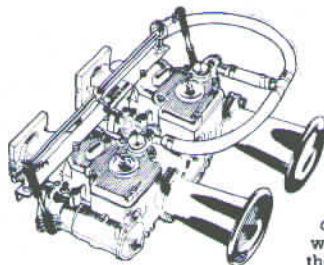

2) Resulting from our competition background built up throughout the 'sixties & 'seventies, we are renowned for our many **Performance Conversions**, including very specialised applications involving, for example, multi-carburettor configurations, for enthusiasts' road cars as well as historic and race / rally cars. We have the experience, knowledge and special data to tackle any carburation requirement.

Reconditioning Service

We operate a reconditioning service for almost ANY carburettor and that includes those models which have now become obsolete. Please ask

for fuller details. Many reconditioned units are available on exchange from stock.

AIR FILTERS

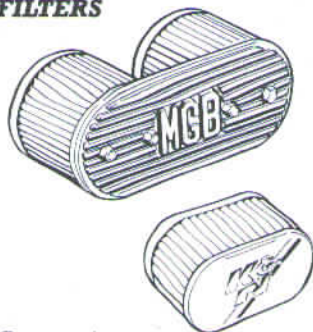

Comp—wire gauze element in chrome body
K & N—pleated reinforced cotton fabric element in chrome body
Pipercross—expanded foam element
Ramflo / Lynx—expanded foam element in plastic body
T.J.—(Tecalemit Jackson) standard replacement filter elements

AIR TRUMPETS

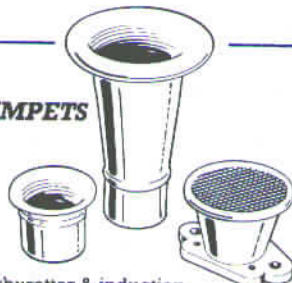

As carburettor & induction specialists, we have a very large selection of various air trumpets to suit most carburettors. Literally hundreds in stock!

MANUAL CHOKE CONVERSIONS

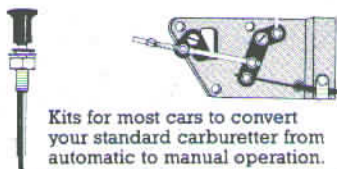

Kits for most cars to convert your standard carburettor from automatic to manual operation.

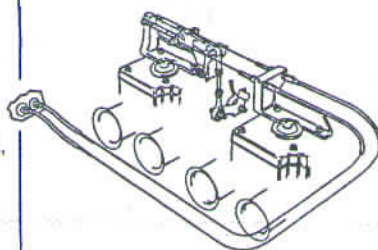

THROTTLE LINKAGES

Timavo • Magard • Lynx • Weber

Essential when a carburettor conversion is fitted which does not allow the original standard throttle arrangement to operate. Twin cable kits are supplied (recommended for motorsport) for extra strength and safety. We also keep all sorts of linkage parts, cables, levers, rod ends, etc.



CAMSHAFTS

Kent & Piper camshafts, followers & timing gear. Full selection of cam profiles for almost any car.

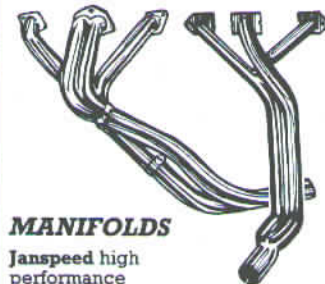
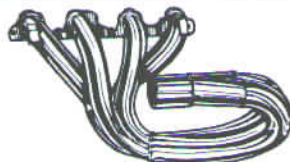

MANIFOLDS

Janspeed high performance exhaust manifolds, systems & conversions. Also, inlet manifolds for increased performance from Lynx • Mangoletsi • Weber.

FUEL REGULATORS

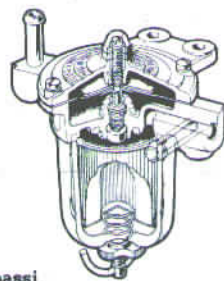

Malpassi

Road & competition versions stocked. Don't forget we also keep all the spares, too.

TURBOCHARGERS

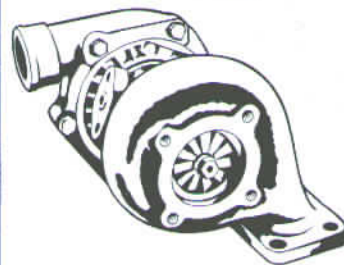

Off-the-shelf service exchange turbos for most vehicles which are fitted with a turbocharger as standard equipment.

Reconditioning Service

We also give a fast reconditioning service on those turbochargers for which we do not hold a replacement unit (i.e. for converted cars) to get your vehicle back on the road in the shortest possible time.

OIL COOLERS

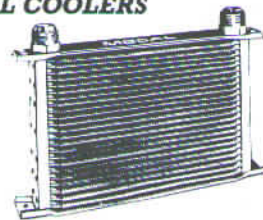

Mocal oil coolers for road and competition use for almost all applications. We keep plenty of spare fittings and hose, too.

IGNITION

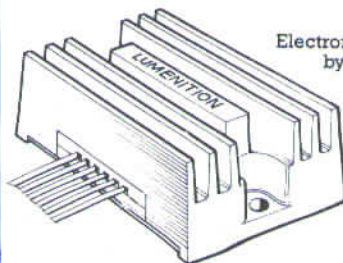

Electronic ignition systems and rev. limiters by **Lumenition**. Generally recognised as the best; selected by Lotus Cars as original equipment and by H.M. Government departments for use on military vehicles.



Replacement points, condensers, rotor arms, distributor caps and coils by **Commercial Ignition & Bosch**. Also, high-performance coils.



NGK. Plugs. Simply the best. Remember, we carry the full range of plugs for road & competition use including the hard-to-find special types of racing plugs. NGK are now the plugs chosen by Rolls Bentley, Jaguar, Aston Martin & Lotus cars.

NGK. HT Leads. Again, the best—selected by top motor manufacturers.



ELECTRICAL

BATTERIES

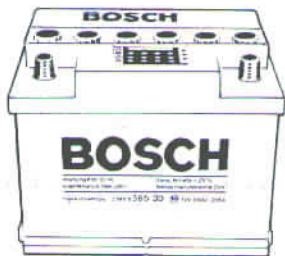

We keep a comprehensive range of Bosch batteries to fit just about every car on the road. Supplied with a 3-year worldwide guarantee, this is the best battery on the market.

ELECTRIC COOLING FANS

We keep all the Kenlowe fan kits, including the original Thermo-matic fan, and masses of spares. And we also stock Kenlowe's other super quality products such as their battery chargers and engine pre-heaters.

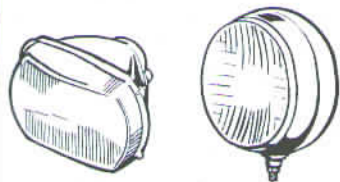
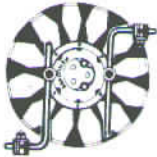

LAMPS & LAMP BRACKETS

Replacement & auxiliary lamps and grille conversion kits from Bosch • Cibie • Hella • Marchal. Lots of special high-wattage bulbs, too! Rowland Kerr lamp brackets for rally & road use. Also, badge-bars of various shapes and sizes made to order.

ALTERNATORS, STARTER MOTORS, DYNAMOS

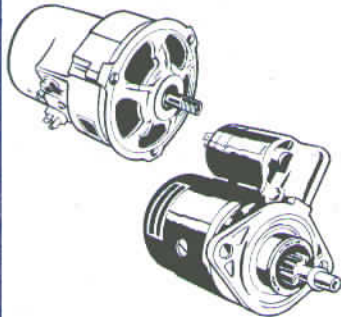

From Bosch, Valeo & Lucas. Don't forget that while we sell all the usual types, we make a particular point of being able to supply units for Continental, Japanese and less usual models.

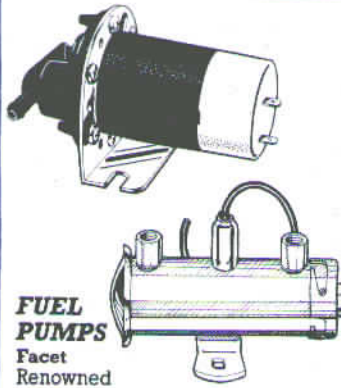

FUEL PUMPS

Facet
Renowned American pumps, used widely for road & competition use.
Huco — German-made pumps, designed as direct replacements for SU, but also very suitable for alternative specialised applications.
S.U. — Full range of replacement pumps in stock.
Pierburg — Compact, universal, high quality German electric pump.

CHASSIS

BRAKE PARTS

High quality Aeroquip brake hoses and fittings; these are mainly for competition use and there are ready-made kits for the popular models, but they are also often used for renovating historic cars etc. Special applications available to order.

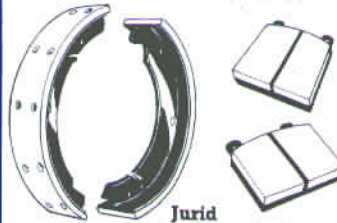

Jurid
brake pads, linings & replacement discs. (Jurid is original equipment on Mercedes & BMW.)

Minex competition linings and pads.

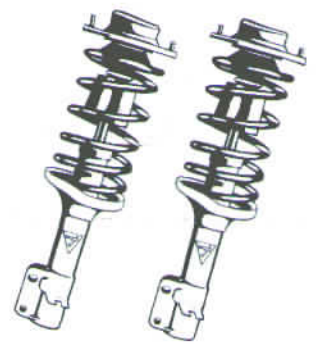

SHOCK ABSORBERS

Replacements for standard units, uprated high-performance units or complete suspension kits for selected vehicles such as Golf GTi, Mercedes, Rover, etc.

Bilstein • Koni • Spax

LUBRICANTS



We keep all the specialised Castrol oils & greases including those for motorsport and special applications. And we stock the much publicised

Mobil Rally 1 synthetic oil which is specially suitable for turbocharged and high-performance engines, plus Mobil synthetic gearbox oil (Mobilube SHC).

WHEELS & BODY STYLING

We'll supply complete styling kits, or separate front/rear spoilers, sills etc. for most cars from Richard Grant and Hella. The full selection of units is too large for us to maintain stocks and so they are available to order only. However, deliveries may be expected within 48 hours of your order unless we notify you to the contrary. Grille kits from Hella • Bosch • Cibie.

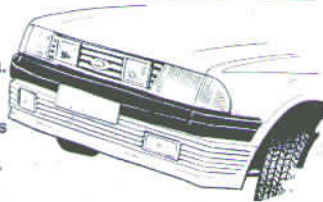

ARC • ATS • BBS • Carmona • Centra • Exip • G.B. • Gotti • Intra • Lorinser • Miglia • Mim • Minilite • Remotec • Revolution • Rial • Ronal • Wolftrace
We can supply wheels from the above list of manufacturers to fit almost any vehicle. Although we do keep a large number of these in stock, we cannot always guarantee to have every size and style available over-the-counter. If we do not have the type you need in stock, we can usually supply, to special order, within 48 hours unless we advise you to the contrary.

Wheels can be supplied already fitted with tyres, balanced and ready to fit to the vehicle.

Dust Shields & Wheel Clean Discs keep brake dust off the wheels. Especially useful for use with alloy wheels to help resist corrosion and to keep the wheels clean.

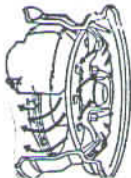

Wheel-nuts for aluminium & steel wheels available for most cars — sold separately.

Locking nuts for steel and alloy wheels available in set of 4 or 5.

INTERIOR

STEERING WHEELS

Leather or wood-rim wheels from Motolita. In our view the best on the market. All British and hand-made from either Connolly hide or selected woods, bonded and rivetted to a one-piece alloy frame. 10" to 15", flat or dished options. We believe we hold the largest stocks in the country of these wheels and bosses & we can supply a wheel for almost any car!

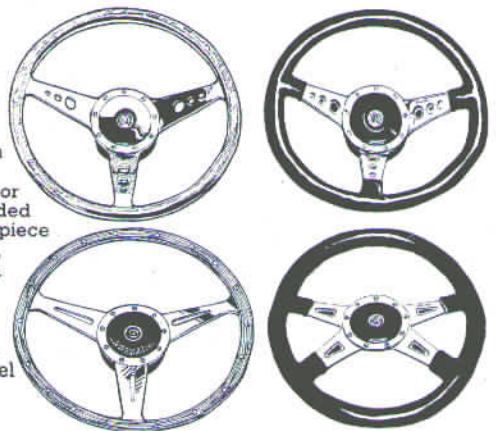

SMITHS INSTRUMENTS

Wide selection of Smiths supplementary instruments and accessories for road or competition use.

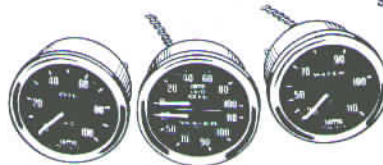

NOTE: Illustrations in this leaflet are protected by copyright and may not be used or reproduced.

For immediate action phone us on

01-794-7766/7

We will process your order straight away. Same day post/Securicor/own van depending on your location. (See over.)

Further product literature is available on request.

TOOLS

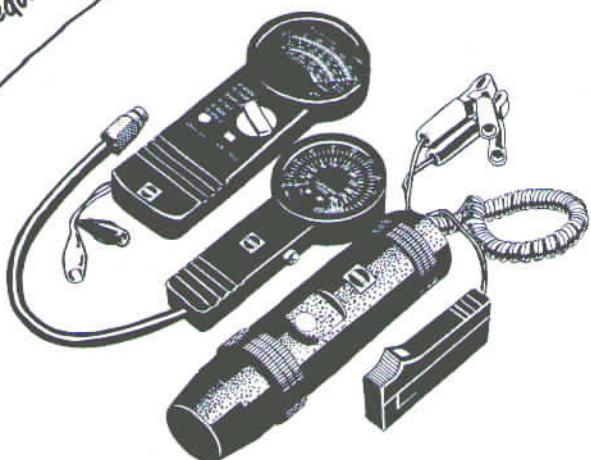

We stock the very fine **Optilux** range of motor testing equipment which includes timing lights, analysers,

compression testers, voltage testers etc. Designed for professional or advanced amateur use.



Highest quality hand-tools and kits which won't break the bank from Sykes-Pickavant. Highly recommended.

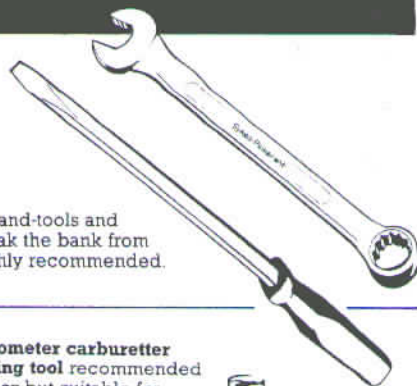

Synchrometer carburetter balancing tool recommended by Weber but suitable for most carburetters when used in conjunction with the various adaptors which are available separately.

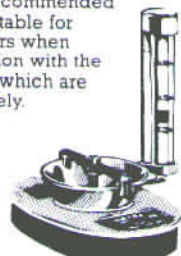

We also stock various carburetter adjusting tools.

COMPETITION ACCESSORIES

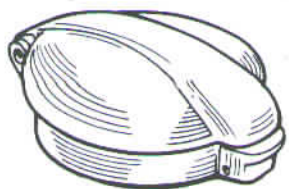

Traditional Petrol Caps
The original flip-up quick-release aluminium petrol filler cap. Competition style - various sizes.

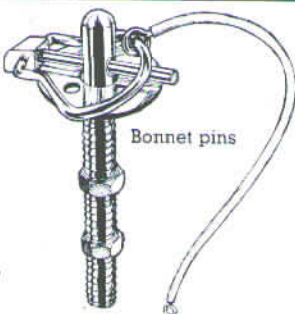

Bonnet pins

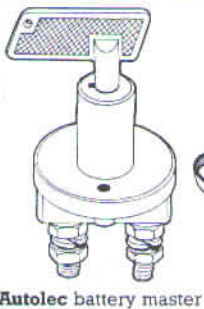

Autolec battery master switch & cut-out switch

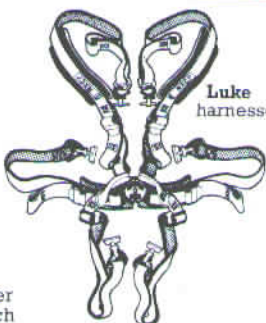

Luke harnesses



Extinguishers

Scrutineer's Delight
Race numbers
Roamers
Lockwire
Wire twisting pliers
Masta tyre gauge
Bonnet hooks
Terry springs
Race tape
Tie-downs
etc. etc.

The purpose of this leaflet is to give a visual reference on the breadth of the special product range which we distribute to the trade throughout London and, indeed, all over Britain. Most people know us principally as carburetter specialists - we have built a fine reputation not only for our comprehensive stockholding but also for our unique knowledge and expertise on carburetter related problems since our appointment as one of the original Weber dealers back in 1955. Such a reputation now extends to engine tuning and diagnosis on all makes of car including fuel injected models.

But of course we have always been heavily involved with many competition and other special products, too, largely as a result of our early days in saloon and single-seater motor racing. Such first-hand experience is invaluable in helping a customer make the right selection to suit their budget and the job in hand.

Now we are expanding our sales activities in these areas which we know best - the less usual shock absorbers, hard-to-find spark plugs, elusive carburetter components, etc.

By the way, don't forget we also supply the trade with top quality replacements for the everyday standard components too - brakes, alternators, etc. - for all UK, Continental and Japanese cars.

TRADE CUSTOMERS

IMMEDIATE RESPONSE TO YOUR ORDERS

We'll take your order over the phone and deal with it right away. Normally goods are sent out by post the same day, right up to the last collection at 5.30 pm. However, depending on the nature of the order, or if you need to be sure of it reaching you the following day, we also use Datapost, or a 24-hour Securicor service (same day despatch of orders received in time for collection at noon). Details can be discussed at the time of ordering.

There are also our own Minivans, of course. Delivery by these depends on your location and usually requires a minimum order value.

Our drivers help out at the counter when they're not on the road and are therefore familiar with most products. They will discuss your needs and cooperate in any way they can when visiting. They can also arrange to let regular customers have further literature on most product ranges if they are needed for frequent reference.

Finally, if you're in a real jam, and you're outside our normal delivery area, we can always use a courier service for same day delivery.

CHRIS MONTAGUE CARBURETTER COMPANY
380 - 382 Finchley Road,
London, NW2 2HP.
Telephone: 01-794 7766 / 7
Telex: 295441 Fax: 01-209 1231

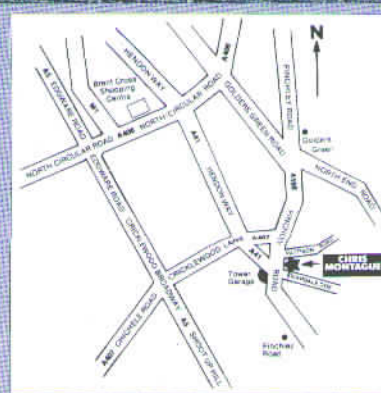

Montague Minivans are familiar and prominent sights on the streets of N. London.

Map: We are sited near the junction of the Hendon Way (A41) with the Finchley Road, near the Tower Garage (Esso station), 1/4 mile north of Finchley Road Underground (Metropolitan & Jubilee lines) & 1/4 mile south of Golders Green Underground (Northern line).

Suppliers to the Garage and Retail Trade.

CHRIS MONTAGUE CARBURETTER CO.

DISTRIBUTORS OF SPECIALISED MOTOR COMPONENTS & ACCESSORIES
Hours: Monday to Saturday 9.00 to 5.30
Closed Sunday

WEBER
SOLEX
S.U.
BOSCH

DELLOORTO
PIEBURG
JURID
NGK

ZENITH
LUCAS
LUMINATION
CIBIE

MALPASSI
MARCHAL
PIPERCROSS
K&N

CHRIS MONTAGUE CARBURETTER CO.

LYNX
KENLOWE
JANSPEED
TURBOCHARGERS

FACET
CASTROL
MOBIL
MOCUL
COMMERCIAL IGNITION
MAGARD

MOTOLITA
KONI
TIMAVO
BILSTEIN

DISTRIBUTORS OF SPECIALISED MOTOR COMPONENTS & ACCESSORIES
380-382 Finchley Road, London, NW2 2HP. Telephone: 01-794 7766/7
Telex No: 295441 Fax No: 01-209 1231

Dear Customer,

Although Chris Montague Carburetter Company has been around for nearly a quarter of a century, we keep being reminded of the fact that not all our customers are familiar with all that we actually do!

So I am enclosing a couple of reminders for you.

First and foremost, of course, we are a carburetter company - in the fullest sense. That means we not only sell almost every make of carburetter, but we actually *stock* them. It means we understand them inside-out and back-to-front. And that includes all applications for all vehicles from historic cars to present day cars, trucks and vans. For road and competition.

It also means that we keep all the spare parts for carburetters: gasket sets, service kits, replacement parts and tuning spares. In fact, we reckon we're the biggest stockists in the UK of carburetter spares, all of which, by the way, are very "postable" items. Remember, next time you're in a jam, we're just a phone call away.

Secondly, and probably as a result of my own earlier background in motor sport, we've always carried a good selection of genuine competition spares and accessories and because we've earned something of a reputation for this, we've expanded our activities in this field.

As specialists we will not only supply any of those items shown on the enclosed leaflets, but we'll also help you out with the more difficult items - less usual shock absorbers, hard-to-find NGK spark plugs, the more obscure MotoLita steering wheels and bosses.....

And don't forget us when it comes to quality replacement parts, too, from famous manufacturers like BOSCH, VALEO, LUCAS, COMMERCIAL IGNITION, etc.

Just pick up the phone and call us direct. You'll be surprised how many ways we can help you.....

Yours sincerely,

C. J. Montague.
Chris Montague

P.S. The enclosed card will remind you of many of the ways we can help you. Please keep it by the phone so it's handy when you need us.